

# Excalibur® - NAB

The **DFT® Excalibur® NAB (Nickel-Aluminum Bronze) Silent Check Valve** is a spring-assisted, nozzle style, non-slam check valve that is designed to withstand the harsh environments of salt and brackish water applications where corrosion resistance and marine life deterrents are a must. DFT's center guided check valves provide reliable, low-maintenance service and solve the problems associated with water hammer and severe applications and environments.



## FEATURES:

- ASME B16.10 Face-to-Face dimensions
  - Spring-assisted silent closing, non-slam
  - 2" to 24" Line size
  - ASME Class 150 & 300
  - Standard body materials:
    - Nickel-Aluminum Bronze
  - Standard ends:
    - Flat face flanged
  - Optional ends:
    - Butt weld
    - Flanged x Butt weld
    - Raised face
  - Center-guided
  - Dual-guided stem
  - Horizontal or vertical installation
  - Tight shutoff
  - Two-piece body
  - Protected spring
  - Easy maintenance
  - Versatile
- Axial flow
  - Nozzle style
  - Options:
    - Soft seat
    - Inconel® X-750 Spring
    - Custom sizing low flow
    - Severe service trim
    - Stellite® trim
  - Trim Options:
    - Nickel-Aluminum Bronze
    - Monel®
    - Stainless Steel
    - Duplex SS

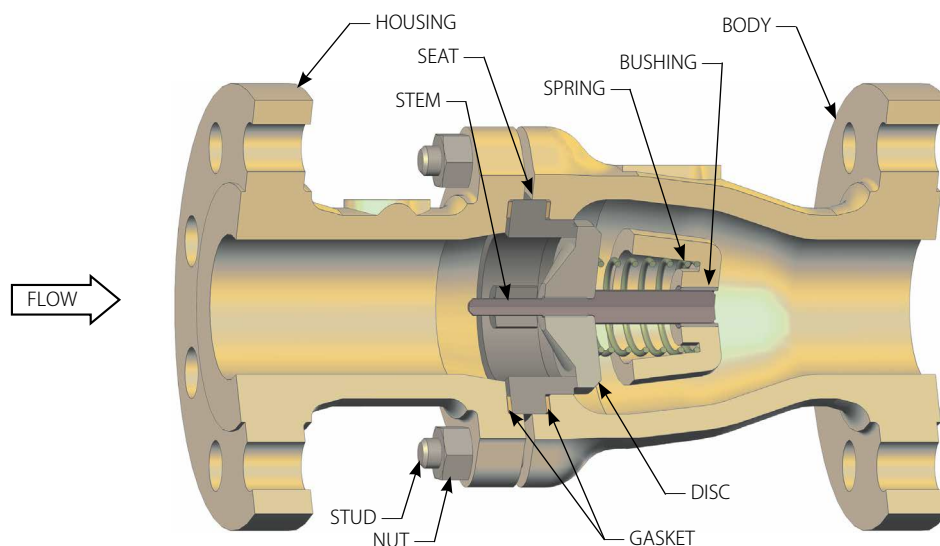

Consult pages 42 and 43 for Pressure/Temperature ratings and soft seat materials.